



# ÍNDICE

# INDEX

<i>CODE</i> CÓDIGO	Pág.	<i>CODE</i> CÓDIGO	Pág.
A-AD-1.6-BNC-00-75	15	A-AD-SMA-SMC-07-50	8
-1.6-BNC-03-75	11	-SMA-TNC-00-50	17
-1.6-BNC-07-75	4	-SMA-TNC-03-50	14
-1.6-TNC-07-75	4	-SMA-TNC-07-50	8
-5/8-F-07-75	4	-SMB-BNC-07-50	8
-716-N-00-50	15	-SMB-MCX-07-50	8
-716-N-03-50	11	-SMB-N-07-50	8
-716-N-07-50	4	-SMB-SMA-07-50	8
-BNC-1.6-07-75	4	-SMB-SMC-00-50	17
-BNC-F-03-75	11	-SMB-SMC-03-50	14
-BNC-F-07-75	4	-SMB-SMC-07-50	8
-BNC-FME-03-50	4	-SMB-TNC-00-50	17
-BNC-MCX-00-50	15	-SMB-TNC-03-50	14
-BNC-MCX-03-50	11	-SMC-BNC-07-50	8
-BNC-MCX-07-50	4	-SMC-MCX-07-50	9
-BNC-N-00-50	15	-SMC-N-07-50	9
-BNC-N-00-75	15	-SMC-SMA-07-50	9
-BNC-N-03-50	11	-SMC-SMB-07-50	9
-BNC-N-03-75	11	-SMC-TNC-00-50	17
-BNC-N-07-50	4	-SMC-TNC-03-50	14
-BNC-N-07-75	4	-SMC-TNC-07-50	9
-BNC-SMA-00-50	15	-TNC-1.6-07-75	9
-BNC-SMA-03-50	11	-TNC-BNC-07-50	9
-BNC-SMA-07-50	5	-TNC-BNC-07-75	9
-BNC-SMB-00-50	15	-TNC-MCX-07-75	9
-BNC-SMB-03-50	11	-TNC-N-07-75	10
-BNC-SMB-07-50	5	-TNC-SMA-07-50	10
-BNC-SMC-00-50	15	-TNC-SMB-07-50	10
-BNC-SMC-03-50	12	-TNC-SMC-07-50	10
-BNC-SMC-07-50	5	-TNC-UHF-03-50	14
-BNC-TNC-00-50	15	-TNC-UHF-07-50	7
-BNC-TNC-00-75	15	-UHF-BNC-07-50	10
-BNC-TNC-03-50	12	-UHF-N-07-50	10
-BNC-TNC-03-75	12	-UHF-TNC-07-50	10
-BNC-TNC-07-50	5		
-BNC-TNC-07-75	5		
-BNC-UHF-00-50	16		
-BNC-UHF-03-50	12		
-BNC-UHF-07-50	5		
-F-BNC-07-75	5		
-F-TNC-03-75	12		
-F-TNC-07-75	5		
-FME-N-03-50	12		
-FME-SMA-03-50	12		
-FME-TNC-03-50	12		
-FME-UHF-03-50	12		
-MCX-BNC-07-50	5		
-MCX-N-00-50	16		
-MCX-N-03-50	13		
-MCX-N-07-50	6		
-MCX-SMA-00-50	16		
-MCX-SMA-03-50	13		
-MCX-SMA-07-50	6		
-MCX-SMB-00-50	16		
-MCX-SMB-03-50	13		
-MCX-SMB-07-50	6		
-MCX-SMC-00-50	16		
-MCX-SMC-03-50	13		
-MCX-SMC-07-50	6		
-MCX-TNC-00-50	16		
-MCX-TNC-03-50	13		
-N-716-07-50	6		
-N-BNC-07-50	6		
-N-BNC-07-75	6		
-N-F-07-75	6		
-N-MCX-07-50	6		
-N-SMA-00-50	16		
-N-SMA-03-50	13		
-N-SMA-07-50	7		
-N-SMB-00-50	16		
-N-SMB-03-50	13		
-N-SMB-07-50	7		
-N-SMC-00-50	17		
-N-SMC-03-50	13		
-N-SMC-07-50	7		
-N-TNC-00-50	17		
-N-TNC-00-75	17		
-N-TNC-03-50	13		
-N-TNC-03-75	13		
-N-TNC-07-50	7		
-N-TNC-07-75	7		
-N-UHF-00-50	17		
-N-UHF-03-50	14		
-N-UHF-07-50	7		
-SMA-BNC-07-50	7		
-SMA-MCX-07-50	7		
-SMA-N-07-50	7		
-SMA-SMB-00-50	17		
-SMA-SMB-03-50	14		
-SMA-SMB-07-50	8		
-SMA-SMC-00-50	17		
-SMA-SMC-03-50	14		

Adaptadores entre series

Adaptors between series

male=m macho=m

female=f hembra=f

m-m f-f m-f

1.6/5.6		5/8"		7/16		BNC		F		FME		MCX		N		SMA		SMB		SMC		TNC		UHF					
m	f	m	f	m	f	m	f	m	f	m	f	m	f	m	f	m	f	m	f	m	f	m	f	m	f	m	f		
						11.1	4.1																4.2			m	1.6/5.6		
						4.5	15.1																9.6			f			
									4.3																	m	5/8"		
																										f			
														11.2	4.4											m	7/16		
														6.6	15.2											f			
11.1	4.1							11.3	4.6	11.4		11.5	4.7	11.6	4.8	11.7	5.1	11.8		12.1	5.3	12.2	5.4	12.3	5.5	m	BNC		
									5.6				6.1	15.3	6.7	15.4	7.6	15.5	8.4	15.6	8.10	15.7	9.7	15.8	10.6	16.1		f	
						11.3	5.6								5.8								12.4	5.7		m	F		
			4.3				4.6							6.8												f			
						11.4								12.5	12.6								12.7	12.8		m	FME		
																										f			
						11.5	6.1							13.1	6.2	13.2	6.3	13.3	6.4	13.4	6.5	13.5				m	MCX		
							4.7	15.3						6.9	16.2	7.7	16.3	8.5	16.4	9.1	16.5	9.8	16.6			f			
						6.6	11.6	6.7		6.8	12.5	13.1	6.9			13.6	7.1	13.7	7.2	13.8	7.3	13.9	7.4	14.1	7.5	m	N		
							4.8	15.4	5.8				6.2	16.2			7.8	16.7	8.6	16.8	9.2	17.1	10.1	17.2	10.7	17.3		f	
						11.7	7.6			12.6		13.2	7.7	13.6	7.8			14.2	8.1	14.3	8.2	14.4	8.3			m	SMA		
							5.1	15.5					6.3	16.3	7.1	16.7			8.7	17.4	9.3	17.5	10.2	17.6		f			
						11.8	8.4					13.3	8.5	13.7	8.6	14.2	8.7			14.5	8.8	14.6	8.9			m	SMB		
							5.2	15.6					6.4	16.4	7.2	16.8	8.1	17.4			9.4	17.7	10.3	17.8		f			
						12.1	8.10					13.4	9.1	13.8	9.2	14.3	9.3	14.5	9.4				14.7	9.5		m	SMC		
							5.3	15.7					6.5	16.5	7.3	17.1	8.2	17.5	8.8	17.7			10.4	17.9		f			
						12.2	9.7	12.4		12.7		13.5	9.8	13.9	10.1	14.4	10.2	14.6	10.3	14.7	10.4				14.8	10.5	m	TNC	
							5.4	15.8	5.7				16.6	7.4	17.2	8.3	17.6	8.9	8.9	9.5	17.9				10.8		f		
							9.6				12.8				14.1	10.7								14.8	10.8		m	UHF	
							5.5	16.1							7.5	17.3								10.5			f		

## Adaptadores macho-hembra

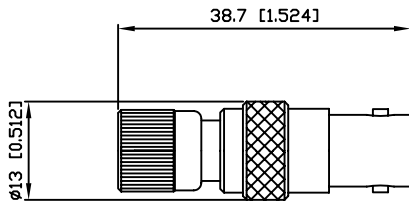

SERIES		$\Omega$	ALFA'R CODE CÓDIGO ALFA'R	TABLE TABLA
m	f			
1.6/5.6	BNC	75	A-AD-1.6-BNC-07-75	4.1

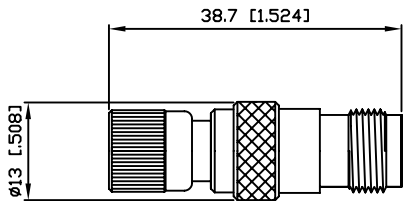

SERIES		$\Omega$	ALFA'R CODE CÓDIGO ALFA'R	TABLE TABLA
m	f			
1.6/5.6	TNC	75	A-AD-1.6-TNC-07-75	4.2

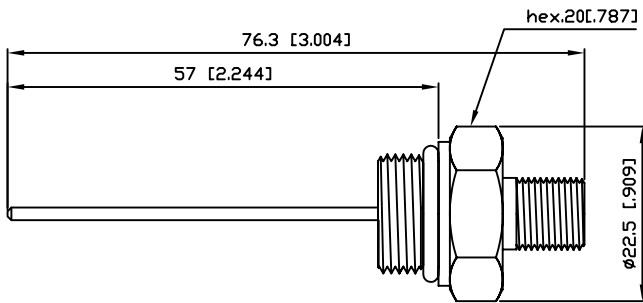

SERIES		$\Omega$	ALFA'R CODE CÓDIGO ALFA'R	TABLE TABLA
m	f			
5/8	F	75	A-AD-5/8-F-07-75	4.3

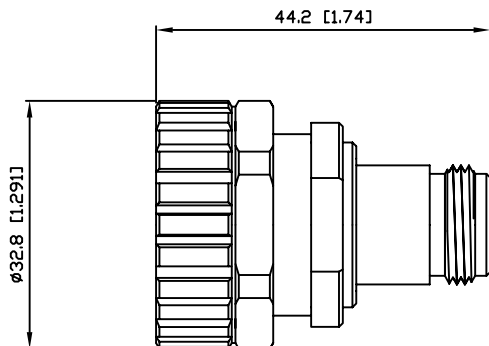

SERIES		$\Omega$	ALFA'R CODE CÓDIGO ALFA'R	TABLE TABLA
m	f			
7/16	N	50	A-AD-716-N-07-50	4.4

## Adaptors male-female

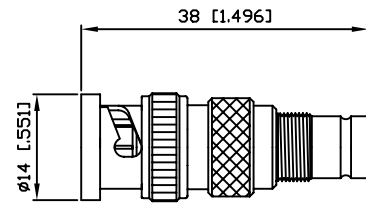

SERIES		$\Omega$	ALFA'R CODE CÓDIGO ALFA'R	TABLE TABLA
m	f			
BNC	1.6/5.6	75	A-AD-BNC-1.6-07-75	4.5

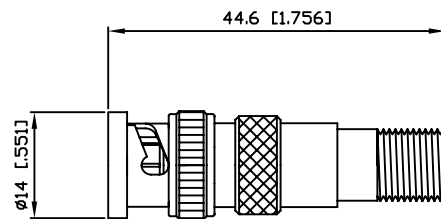

SERIES		$\Omega$	ALFA'R CODE CÓDIGO ALFA'R	TABLE TABLA
m	f			
BNC	F	75	A-AD-BNC-F-07-75	4.6

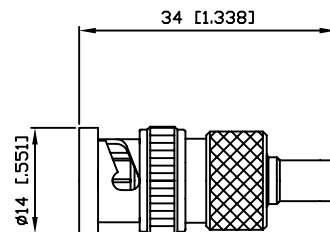

SERIES		$\Omega$	ALFA'R CODE CÓDIGO ALFA'R	TABLE TABLA
m	f			
BNC	MCX	50	A-AD-BNC-MCX-07-50	4.7

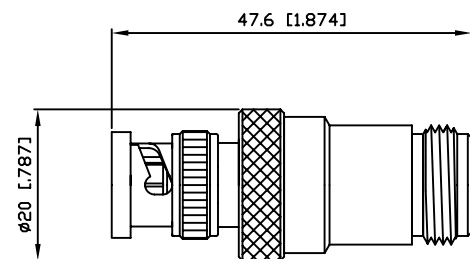

SERIES		$\Omega$	ALFA'R CODE CÓDIGO ALFA'R	TABLE TABLA
m	f			
BNC	N	50	A-AD-BNC-N-07-50	4.8
		75	A-AD-BNC-N-07-75	

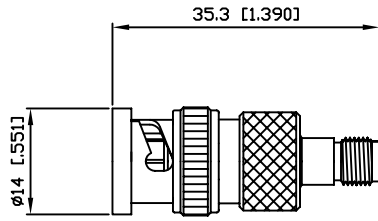

SERIES		$\Omega$	<i>ALFA'R CODE</i> CÓDIGO ALFA'R	TABLE TABLA
m	f			
BNC	SMA	50	A-AD-BNC-SMA-07-50	5.1

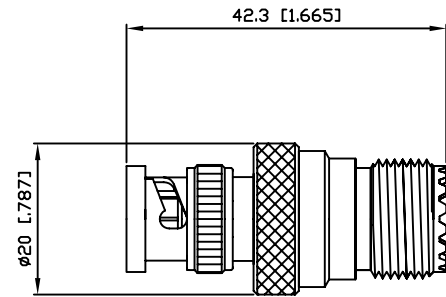

SERIES		$\Omega$	<i>ALFA'R CODE</i> CÓDIGO ALFA'R	TABLE TABLA
m	f			
BNC	UHF	50	A-AD-BNC-UHF-07-50	5.5

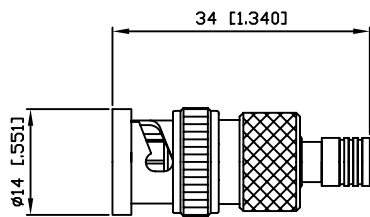

SERIES		$\Omega$	<i>ALFA'R CODE</i> CÓDIGO ALFA'R	TABLE TABLA
m	f			
BNC	SMB	50	A-AD-BNC-SMB-07-50	5.2

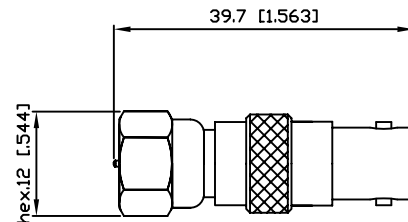

SERIES		$\Omega$	<i>ALFA'R CODE</i> CÓDIGO ALFA'R	TABLE TABLA
m	f			
F	BNC	75	A-AD-F-BNC-07-75	5.6

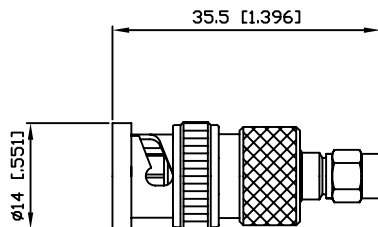

SERIES		$\Omega$	<i>ALFA'R CODE</i> CÓDIGO ALFA'R	TABLE TABLA
m	f			
BNC	SMC	50	A-AD-BNC-SMC-07-50	5.3

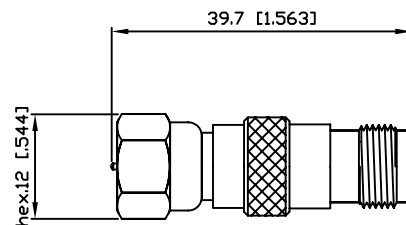

SERIES		$\Omega$	<i>ALFA'R CODE</i> CÓDIGO ALFA'R	TABLE TABLA
m	f			
F	TNC	75	A-AD-F-TNC-07-75	5.7

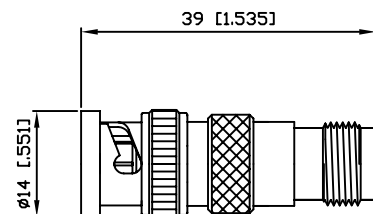

SERIES		$\Omega$	<i>ALFA'R CODE</i> CÓDIGO ALFA'R	TABLE TABLA
m	f			
BNC	TNC	50	A-AD-BNC-TNC-07-50	5.4
		75	A-AD-BNC-TNC-07-75	

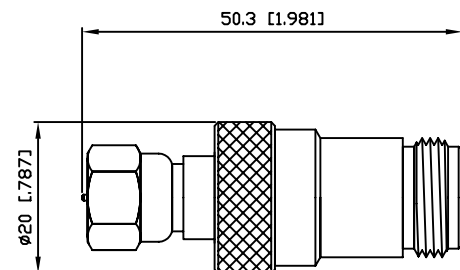

SERIES		$\Omega$	<i>ALFA'R CODE</i> CÓDIGO ALFA'R	TABLE TABLA
m	f			
BNC	TNC	50	A-AD-F-N-07-50	5.8
		75	A-AD-F-N-07-75	

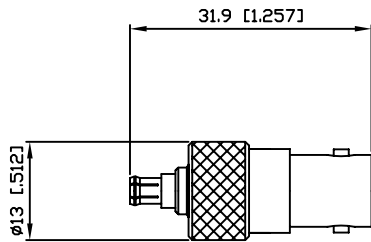

SERIES		$\Omega$	ALFA'R CODE CÓDIGO ALFA'R	TABLE TABLA
m	f			
MCX	BNC	50	A-AD-MCX-BNC-07-50	6.1

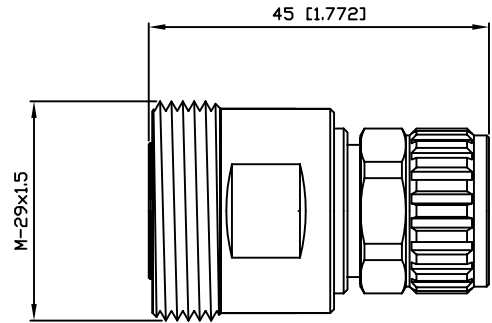

SERIES		$\Omega$	ALFA'R CODE CÓDIGO ALFA'R	TABLE TABLA
m	f			
N	7/16	50	A-AD-N-716-07-50	6.6

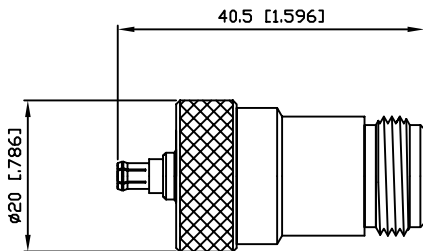

SERIES		$\Omega$	ALFA'R CODE CÓDIGO ALFA'R	TABLE TABLA
m	f			
MCX	N	50	A-AD-MCX-N-07-50	6.2

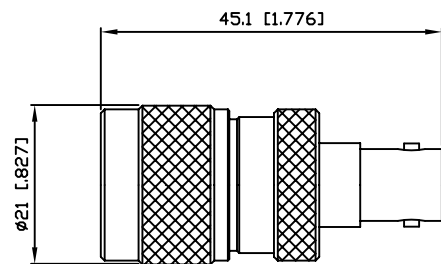

SERIES		$\Omega$	ALFA'R CODE CÓDIGO ALFA'R	TABLE TABLA
m	f			
N	BNC	50	A-AD-N-BNC-07-50	6.7
		75	A-AD-N-BNC-07-75	

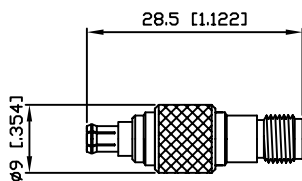

SERIES		$\Omega$	ALFA'R CODE CÓDIGO ALFA'R	TABLE TABLA
m	f			
MCX	SMA	50	A-AD-MCX-SMA-07-50	6.3

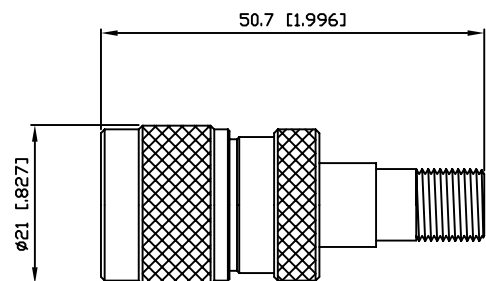

SERIES		$\Omega$	ALFA'R CODE CÓDIGO ALFA'R	TABLE TABLA
m	f			
N	F	75	A-AD-N-F-07-75	6.8

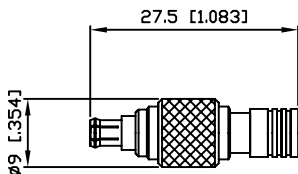

SERIES		$\Omega$	ALFA'R CODE CÓDIGO ALFA'R	TABLE TABLA
m	f			
MCX	SMB	50	A-AD-MCX-SMB-07-50	6.4

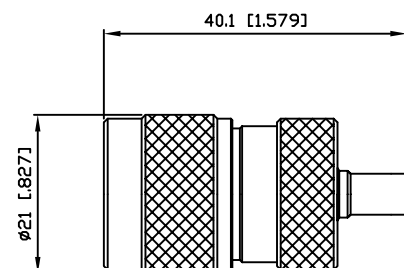

SERIES		$\Omega$	ALFA'R CODE CÓDIGO ALFA'R	TABLE TABLA
m	f			
N	MCX	50	A-AD-N-MCX-07-50	6.9

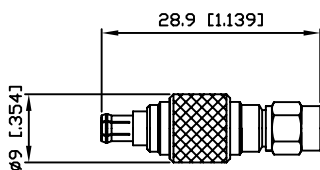

SERIES		$\Omega$	ALFA'R CODE CÓDIGO ALFA'R	TABLE TABLA
m	f			
MCX	SMC	50	A-AD-MCX-SMC-07-50	6.5

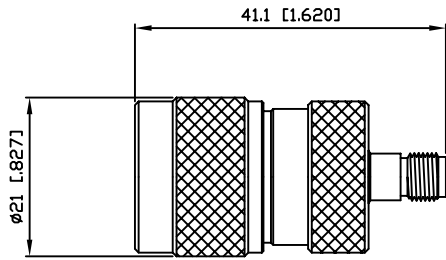

SERIES		$\Omega$	ALFA'R CODE CÓDIGO ALFA'R	TABLE TABLA
m	f			
N	SMA	50	A-AD-N-SMA-07-50	7.1

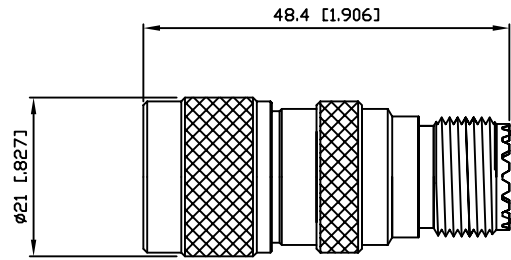

SERIES		$\Omega$	ALFA'R CODE CÓDIGO ALFA'R	TABLE TABLA
m	f			
N	UHF	50	A-AD-N-UHF-07-50	7.5

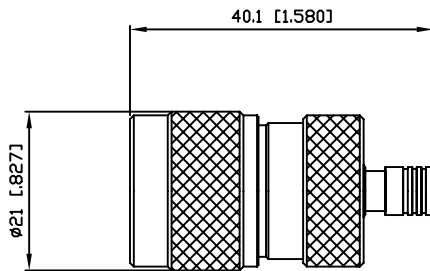

SERIES		$\Omega$	ALFA'R CODE CÓDIGO ALFA'R	TABLE TABLA
m	f			
N	SMB	50	A-AD-N-SMB-07-50	7.2

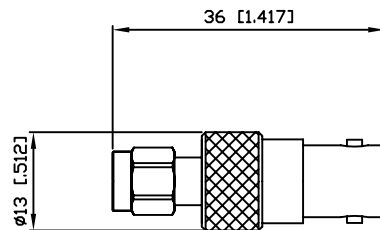

SERIES		$\Omega$	ALFA'R CODE CÓDIGO ALFA'R	TABLE TABLA
m	f			
SMA	BNC	50	A-AD-SMA-BNC-07-50	7.6

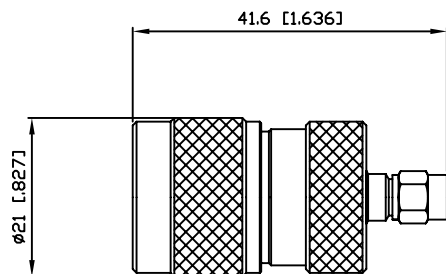

SERIES		$\Omega$	ALFA'R CODE CÓDIGO ALFA'R	TABLE TABLA
m	f			
N	SMC	50	A-AD-N-SMC-07-50	7.3

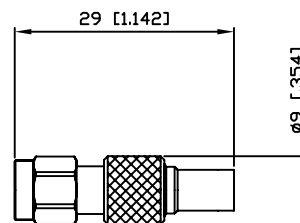

SERIES		$\Omega$	ALFA'R CODE CÓDIGO ALFA'R	TABLE TABLA
m	f			
SMA	MCX	50	A-AD-SMA-MCX-07-50	7.7

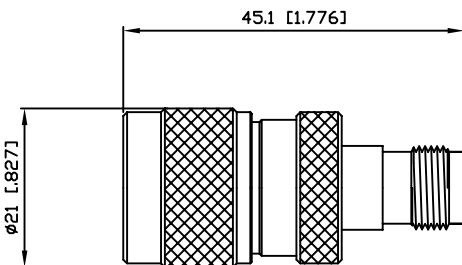

SERIES		$\Omega$	ALFA'R CODE CÓDIGO ALFA'R	TABLE TABLA
m	f			
N	TNC	50	A-AD-N-TNC-07-50	7.4
		75	A-AD-N-TNC-07-75	

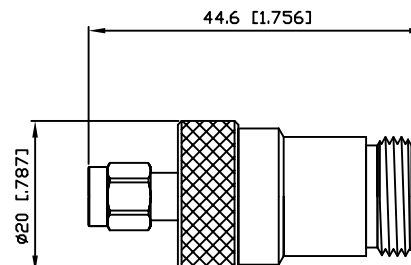

SERIES		$\Omega$	ALFA'R CODE CÓDIGO ALFA'R	TABLE TABLA
m	f			
SMA	N	50	A-AD-SMA-N-07-50	7.8

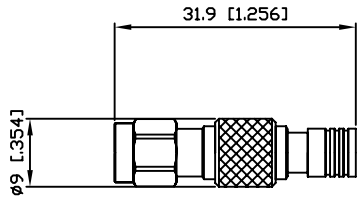

SERIES		$\Omega$	<i>ALFA'R CODE</i> CÓDIGO ALFA'R	TABLE TABLA
m	f			
SMA	SMB	50	A-AD-SMA-SMB-07-50	8.1

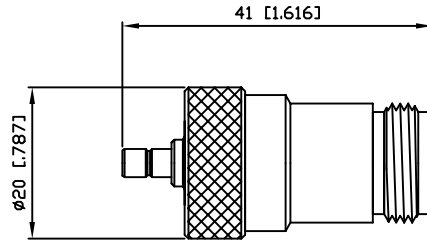

SERIES		$\Omega$	<i>ALFA'R CODE</i> CÓDIGO ALFA'R	TABLE TABLA
m	f			
SMB	N	50	A-AD-SMB-N-07-50	8.6

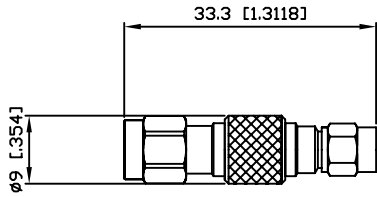

SERIES		$\Omega$	<i>ALFA'R CODE</i> CÓDIGO ALFA'R	TABLE TABLA
m	f			
SMA	SMC	50	A-AD-SMA-SMC-07-50	8.2

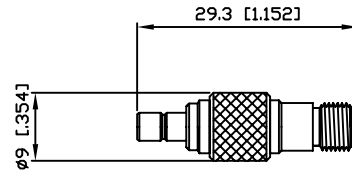

SERIES		$\Omega$	<i>ALFA'R CODE</i> CÓDIGO ALFA'R	TABLE TABLA
m	f			
SMB	SMA	50	A-AD-SMB-SMA-07-50	8.7

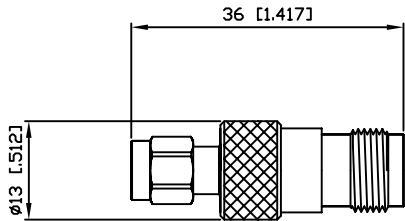

SERIES		$\Omega$	<i>ALFA'R CODE</i> CÓDIGO ALFA'R	TABLE TABLA
m	f			
SMA	TNC	50	A-AD-SMA-TNC-07-50	8.3

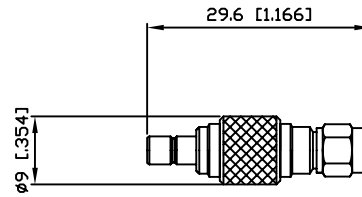

SERIES		$\Omega$	<i>ALFA'R CODE</i> CÓDIGO ALFA'R	TABLE TABLA
m	f			
SMB	SMC	50	A-AD-SMB-SMC-07-50	8.8

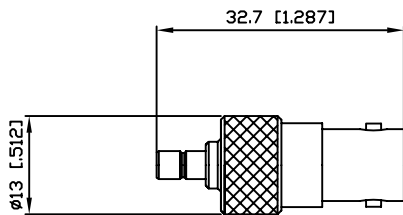

SERIES		$\Omega$	<i>ALFA'R CODE</i> CÓDIGO ALFA'R	TABLE TABLA
m	f			
SMB	BNC	50	A-AD-SMB-BNC-07-50	8.4

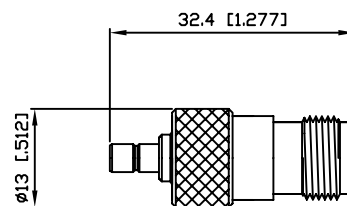

SERIES		$\Omega$	<i>ALFA'R CODE</i> CÓDIGO ALFA'R	TABLE TABLA
m	f			
SMB	TNC	50	A-AD-SMB-TNC-07-50	8.9

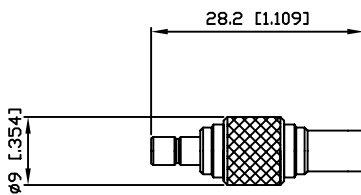

SERIES		$\Omega$	<i>ALFA'R CODE</i> CÓDIGO ALFA'R	TABLE TABLA
m	f			
SMB	MCX	50	A-AD-SMB-MCX-07-50	8.5

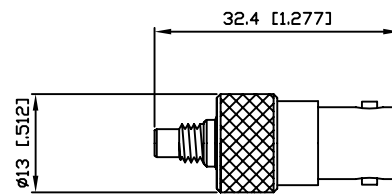

SERIES		$\Omega$	<i>ALFA'R CODE</i> CÓDIGO ALFA'R	TABLE TABLA
m	f			
SMC	BNC	50	A-AD-SMC-BNC-07-50	8.10



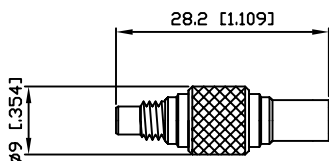

SERIES		$\Omega$	ALFA'R CODE CÓDIGO ALFA'R	TABLE TABLA
m	f			
SMC	MCX	50	A-AD-SMC-MCX-07-50	9.1

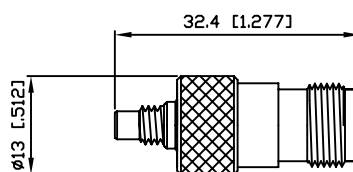

SERIES		$\Omega$	ALFA'R CODE CÓDIGO ALFA'R	TABLE TABLA
m	f			
SMC	TNC	50	A-AD-SMC-TNC-07-50	9.5

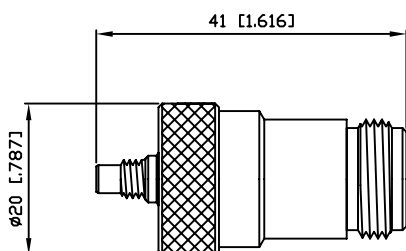

SERIES		$\Omega$	ALFA'R CODE CÓDIGO ALFA'R	TABLE TABLA
m	f			
SMC	N	50	A-AD-SMC-N-07-50	9.2

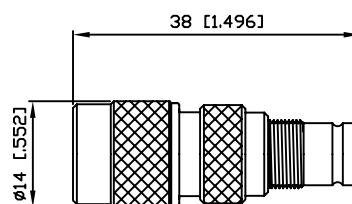

SERIES		$\Omega$	ALFA'R CODE CÓDIGO ALFA'R	TABLE TABLA
m	f			
TNC	1.6/5.6	75	A-AD-TNC-1.6-07-75	9.6

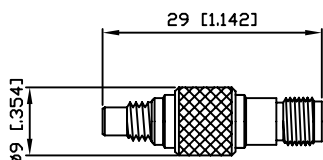

SERIES		$\Omega$	ALFA'R CODE CÓDIGO ALFA'R	TABLE TABLA
m	f			
SMC	SMA	50	A-AD-SMC-SMA-07-50	9.3

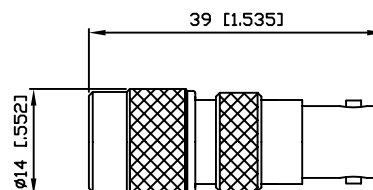

SERIES		$\Omega$	ALFA'R CODE CÓDIGO ALFA'R	TABLE TABLA
m	f			
TNC	BNC	50	A-AD-TNC-BNC-07-50	9.7
		75	A-AD-TNC-BNC-07-75	

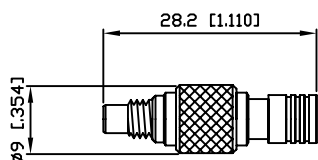

SERIES		$\Omega$	ALFA'R CODE CÓDIGO ALFA'R	TABLE TABLA
m	f			
SMC	SMB	50	A-AD-SMC-SMB-07-50	9.4

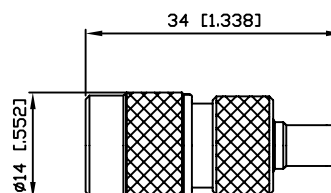

SERIES		$\Omega$	ALFA'R CODE CÓDIGO ALFA'R	TABLE TABLA
m	f			
TNC	MCX	50	A-AD-TNC-MCX-07-50	9.8

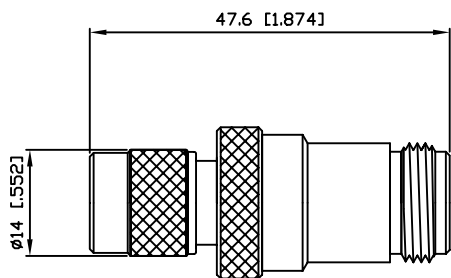

SERIES		$\Omega$	ALFA'R CODE CÓDIGO ALFA'R	TABLE TABLA
m	f			
TNC	N	50	A-AD-TNC-N-07-50	10.1
		75	A-AD-TNC-N-07-75	

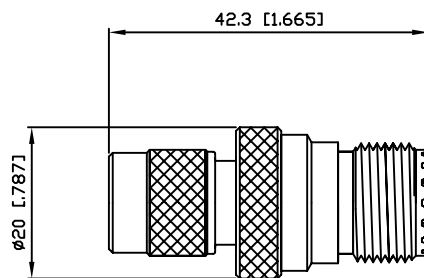

SERIES		$\Omega$	ALFA'R CODE CÓDIGO ALFA'R	TABLE TABLA
m	f			
TNC	UHF	50	A-AD-TNC-UHF-07-50	10.5

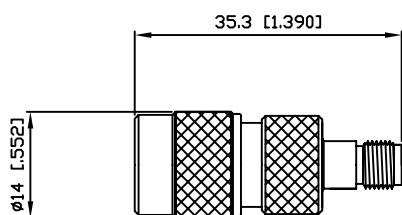

SERIES		$\Omega$	ALFA'R CODE CÓDIGO ALFA'R	TABLE TABLA
m	f			
TNC	SMA	50	A-AD-TNC-SMA-07-50	10.2

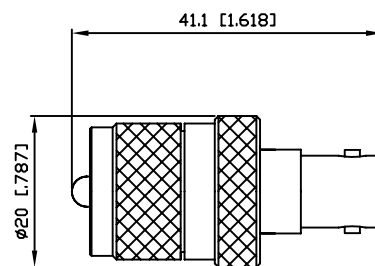

SERIES		$\Omega$	ALFA'R CODE CÓDIGO ALFA'R	TABLE TABLA
m	f			
UHF	BNC	50	A-AD-UHF-BNC-07-50	10.6

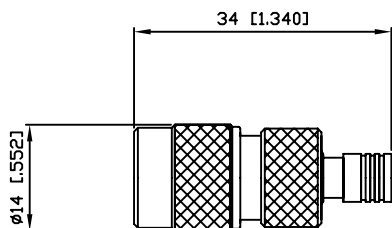

SERIES		$\Omega$	ALFA'R CODE CÓDIGO ALFA'R	TABLE TABLA
m	f			
TNC	SMB	50	A-AD-TNC-SMB-07-50	10.3

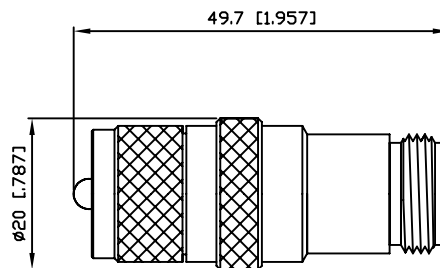

SERIES		$\Omega$	ALFA'R CODE CÓDIGO ALFA'R	TABLE TABLA
m	f			
UHF	N	50	A-AD-UHF-N-07-50	10.7

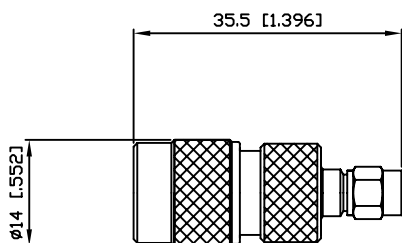

SERIES		$\Omega$	ALFA'R CODE CÓDIGO ALFA'R	TABLE TABLA
m	f			
TNC	SMC	50	A-AD-TNC-SMC-07-50	10.4

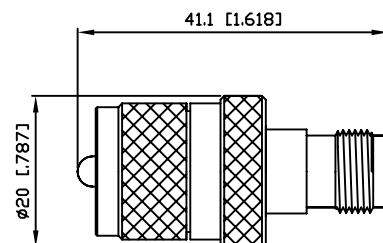

SERIES		$\Omega$	ALFA'R CODE CÓDIGO ALFA'R	TABLE TABLA
m	f			
UHF	TNC	50	A-AD-UHF-TNC-07-50	10.8

## Adaptadores macho-macho

## Adaptors male-male

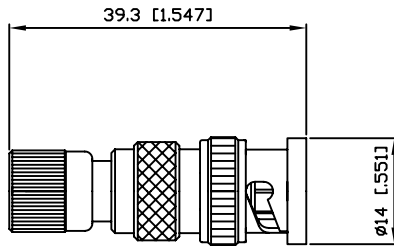

SERIES		$\Omega$	ALFA'R CODE CÓDIGO ALFA'R	TABLE TABLA
m	m			
1.6/5.6	BNC	75	A-AD-1.6-BNC-03-75	11.1

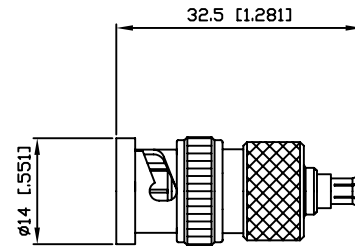

SERIES		$\Omega$	ALFA'R CODE CÓDIGO ALFA'R	TABLE TABLA
m	m			
BNC	MCX	50	A-AD-BNC-MCX-03-50	11.5

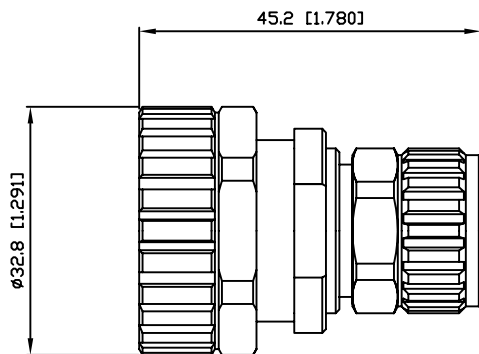

SERIES		$\Omega$	ALFA'R CODE CÓDIGO ALFA'R	TABLE TABLA
m	m			
7/16	N	50	A-AD-716-N-03-50	11.2

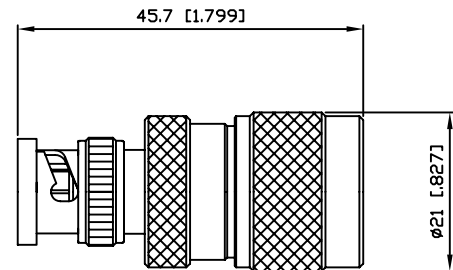

SERIES		$\Omega$	ALFA'R CODE CÓDIGO ALFA'R	TABLE TABLA
m	m			
BNC	N	50	A-AD-BNC-N-03-50	11.6
		50	A-AD-BNC-N-03-50	

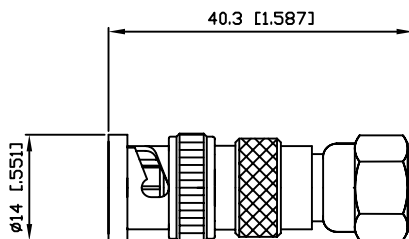

SERIES		$\Omega$	ALFA'R CODE CÓDIGO ALFA'R	TABLE TABLA
m	m			
BNC	F	75	A-AD-BNC-F-03-75	11.3

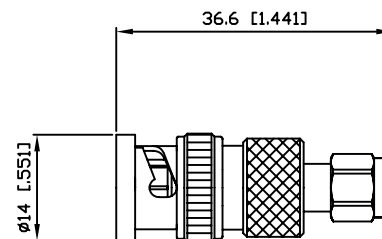

SERIES		$\Omega$	ALFA'R CODE CÓDIGO ALFA'R	TABLE TABLA
m	m			
BNC	SMA	50	A-AD-BNC-SMA-03-50	11.7

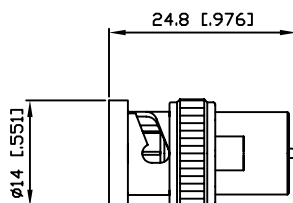

SERIES		$\Omega$	ALFA'R CODE CÓDIGO ALFA'R	TABLE TABLA
m	m			
BNC	FME	50	A-AD-BNC-FME-03-50	11.4

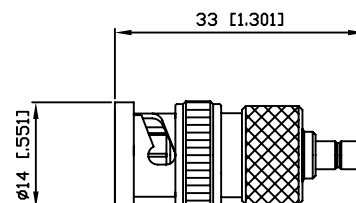

SERIES		$\Omega$	ALFA'R CODE CÓDIGO ALFA'R	TABLE TABLA
m	m			
BNC	SMB	50	A-AD-BNC-SMB-03-50	11.8

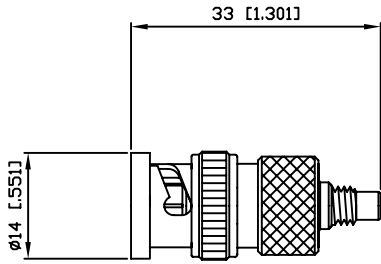

SERIES		$\Omega$	<i>ALFA'R CODE</i> CÓDIGO ALFA'R	TABLE TABLA
m	m			
BNC	SMC	50	A-AD-BNC-SMC-03-50	12.1

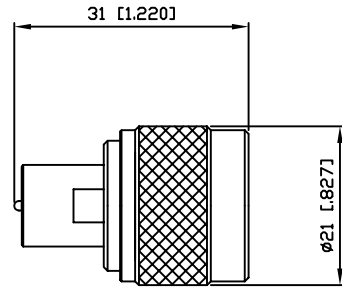

SERIES		$\Omega$	<i>ALFA'R CODE</i> CÓDIGO ALFA'R	TABLE TABLA
m	m			
FME	N	50	A-AD-FME-N-03-50	12.5

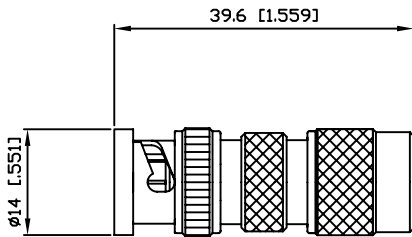

SERIES		$\Omega$	<i>ALFA'R CODE</i> CÓDIGO ALFA'R	TABLE TABLA
m	m			
BNC	TNC	50	A-AD-BNC-TNC-03-50	12.2
		75	A-AD-BNC-TNC-03-75	

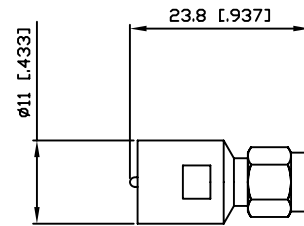

SERIES		$\Omega$	<i>ALFA'R CODE</i> CÓDIGO ALFA'R	TABLE TABLA
m	m			
FME	SMA	50	A-AD-FME-SMA-03-50	12.6

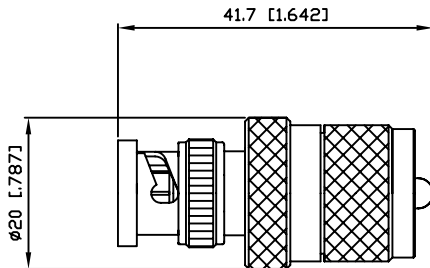

SERIES		$\Omega$	<i>ALFA'R CODE</i> CÓDIGO ALFA'R	TABLE TABLA
m	m			
BNC	UHF	50	A-AD-BNC-UHF-03-50	12.3

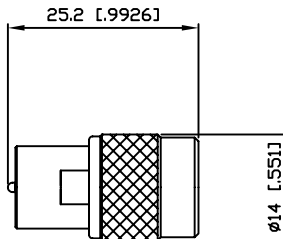

SERIES		$\Omega$	<i>ALFA'R CODE</i> CÓDIGO ALFA'R	TABLE TABLA
m	m			
FME	TNC	50	A-AD-FME-TNC-03-50	12.7

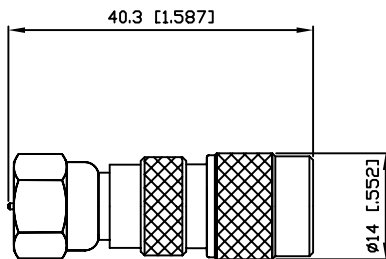

SERIES		$\Omega$	<i>ALFA'R CODE</i> CÓDIGO ALFA'R	TABLE TABLA
m	m			
F	TNC	75	A-AD-F-TNC-03-75	12.4

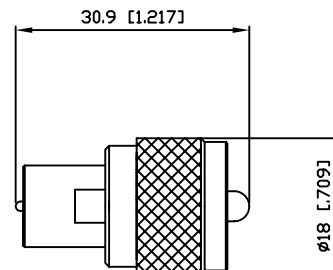

SERIES		$\Omega$	<i>ALFA'R CODE</i> CÓDIGO ALFA'R	TABLE TABLA
m	m			
FME	UHF	50	A-AD-FME-UHF-03-50	12.8

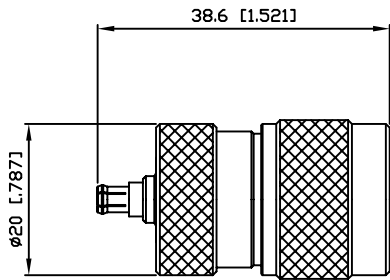

SERIES		$\Omega$	ALFA'R CODE CÓDIGO ALFA'R	TABLE TABLA
m	m			
MCX	N	50	A-AD-MCX-N-03-50	13.1

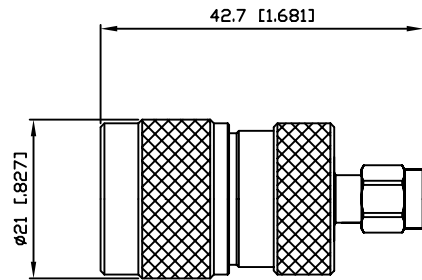

SERIES		$\Omega$	ALFA'R CODE CÓDIGO ALFA'R	TABLE TABLA
m	m			
N	SMA	50	A-AD-N-SMA-03-50	13.6

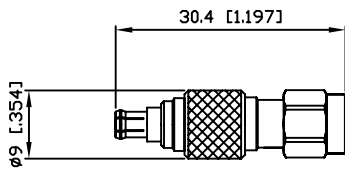

SERIES		$\Omega$	ALFA'R CODE CÓDIGO ALFA'R	TABLE TABLA
m	m			
MCX	SMA	50	A-AD-MCX-SMA-03-50	13.2

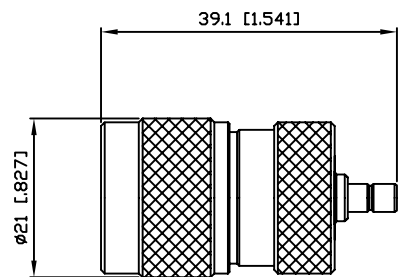

SERIES		$\Omega$	ALFA'R CODE CÓDIGO ALFA'R	TABLE TABLA
m	m			
N	SMB	50	A-AD-N-SMB-03-50	13.7

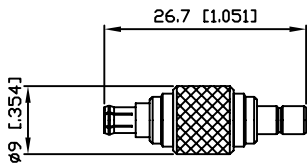

SERIES		$\Omega$	ALFA'R CODE CÓDIGO ALFA'R	TABLE TABLA
m	m			
MCX	SMB	50	A-AD-MCX-SMB-03-50	13.3

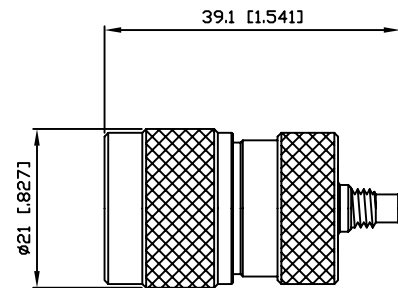

SERIES		$\Omega$	ALFA'R CODE CÓDIGO ALFA'R	TABLE TABLA
m	m			
N	SMC	50	A-AD-N-SMC-03-50	13.8

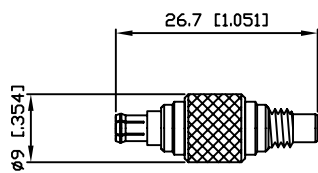

SERIES		$\Omega$	ALFA'R CODE CÓDIGO ALFA'R	TABLE TABLA
m	m			
MCX	SMC	50	A-AD-MCX-SMC-03-50	13.4

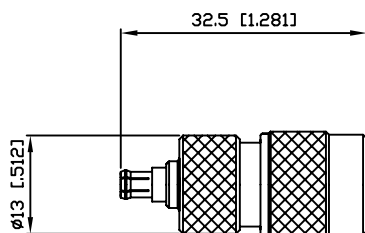

SERIES		$\Omega$	ALFA'R CODE CÓDIGO ALFA'R	TABLE TABLA
m	m			
MCX	TNC	50	A-AD-MCX-TNC-03-50	13.5

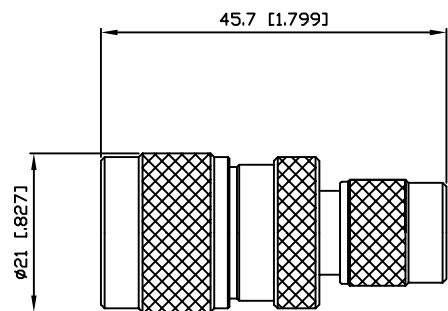

SERIES		$\Omega$	ALFA'R CODE CÓDIGO ALFA'R	TABLE TABLA
m	m			
N	TNC	50	A-AD-N-TNC-03-50	13.9
		75	A-AD-N-TNC-03-75	

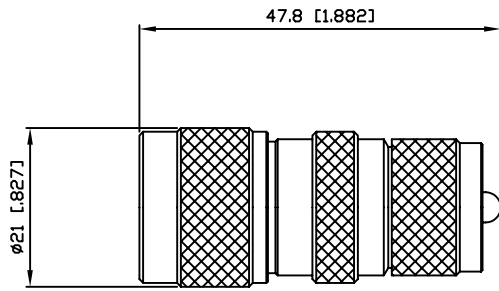

SERIES		$\Omega$	<i>ALFA'R CODE</i> CÓDIGO ALFA'R	TABLE TABLA
m	m			
N	UHF	50	A-AD-N-UHF-03-50	14.1

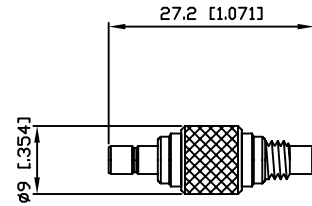

SERIES		$\Omega$	<i>ALFA'R CODE</i> CÓDIGO ALFA'R	TABLE TABLA
m	m			
SMB	SMC	50	A-AD-SMB-SMC-03-50	14.5

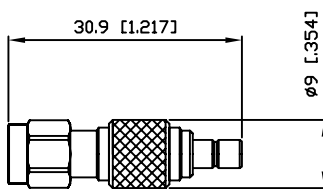

SERIES		$\Omega$	<i>ALFA'R CODE</i> CÓDIGO ALFA'R	TABLE TABLA
m	m			
SMA	SMB	50	A-AD-SMA-SMB-03-50	14.2

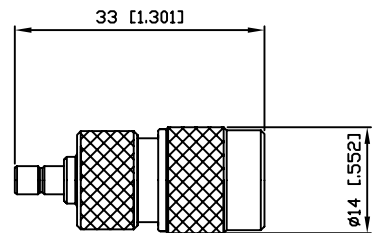

SERIES		$\Omega$	<i>ALFA'R CODE</i> CÓDIGO ALFA'R	TABLE TABLA
m	m			
SMB	TNC	50	A-AD-SMB-TNC-03-50	14.6

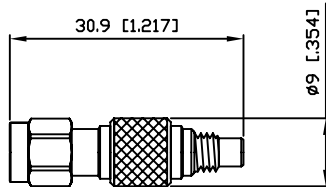

SERIES		$\Omega$	<i>ALFA'R CODE</i> CÓDIGO ALFA'R	TABLE TABLA
m	m			
SMA	SMC	50	A-AD-SMA-SMC-03-50	14.3

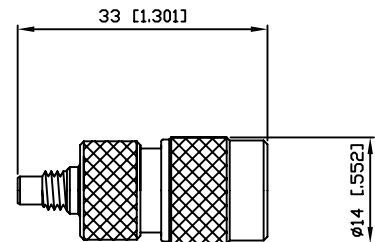

SERIES		$\Omega$	<i>ALFA'R CODE</i> CÓDIGO ALFA'R	TABLE TABLA
m	m			
SMC	TNC	50	A-AD-SMC-TNC-03-50	14.7

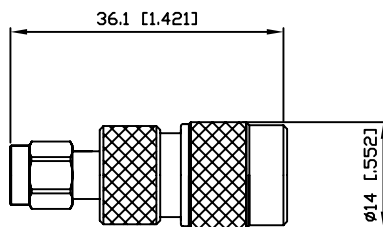

SERIES		$\Omega$	<i>ALFA'R CODE</i> CÓDIGO ALFA'R	TABLE TABLA
m	m			
SMA	TNC	50	A-AD-SMA-TNC-03-50	14.4

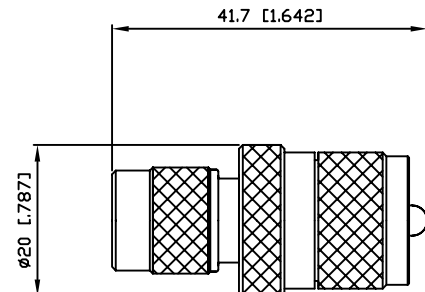

SERIES		$\Omega$	<i>ALFA'R CODE</i> CÓDIGO ALFA'R	TABLE TABLA
m	m			
TNC	UHF	50	A-AD-TNC-UHF-03-50	14.8

## Adaptadores hembra-hembra

## Adaptors female-female

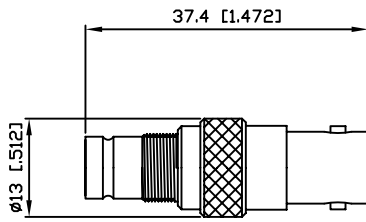

SERIES		$\Omega$	ALFA'R CODE CÓDIGO ALFA'R	TABLE TABLA
f	f			
1.6/5.6	BNC	75	A-AD-1.6-BNC-00-75	15.1

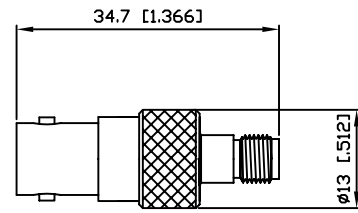

SERIES		$\Omega$	ALFA'R CODE CÓDIGO ALFA'R	TABLE TABLA
f	f			
BNC	SMA	50	A-AD-BNC-SMA-00-50	15.5

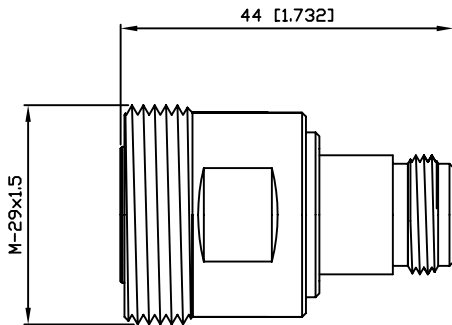

SERIES		$\Omega$	ALFA'R CODE CÓDIGO ALFA'R	TABLE TABLA
f	f			
7/16	N	50	A-AD-716-N-00-50	15.2

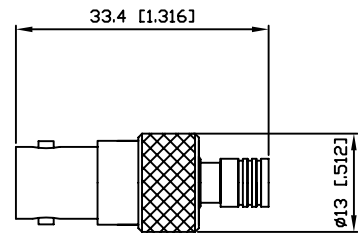

SERIES		$\Omega$	ALFA'R CODE CÓDIGO ALFA'R	TABLE TABLA
f	f			
BNC	SMB	50	A-AD-BNC-SMB-00-50	15.6

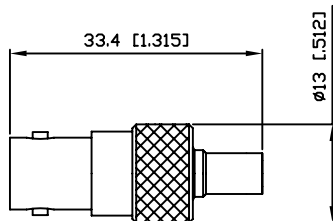

SERIES		$\Omega$	ALFA'R CODE CÓDIGO ALFA'R	TABLE TABLA
f	f			
BNC	MCX	50	A-AD-BNC-MCX-00-50	15.3

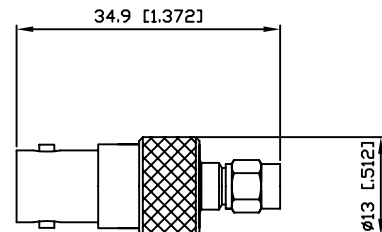

SERIES		$\Omega$	ALFA'R CODE CÓDIGO ALFA'R	TABLE TABLA
f	f			
BNC	SMC	50	A-AD-BNC-SMC-00-50	15.7

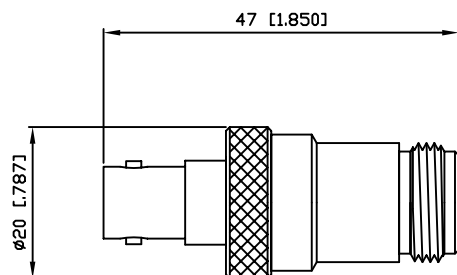

SERIES		$\Omega$	ALFA'R CODE CÓDIGO ALFA'R	TABLE TABLA
f	f			
BNC	N	50	A-AD-BNC-N-00-50	15.4
		75	A-AD-BNC-N-00-75	

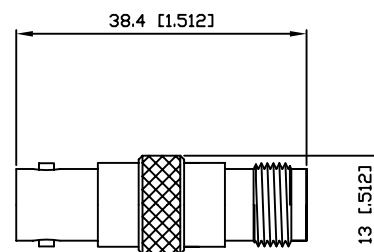

SERIES		$\Omega$	ALFA'R CODE CÓDIGO ALFA'R	TABLE TABLA
f	f			
BNC	TNC	50	A-AD-BNC-TNC-00-50	15.8
		75	A-AD-BNC-TNC-00-75	

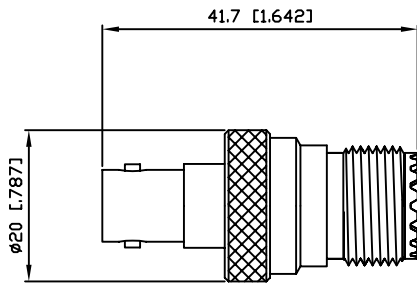

SERIES		$\Omega$	<i>ALFA'R CODE</i> CÓDIGO ALFA'R	TABLE TABLA
f	f			
BNC	UHF	50	A-AD-BNC-UHF-00-50	16.1

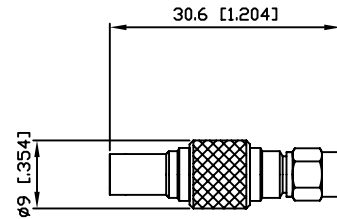

SERIES		$\Omega$	<i>ALFA'R CODE</i> CÓDIGO ALFA'R	TABLE TABLA
f	f			
MCX	SMC	50	A-AD-MCX-SMC-00-50	16.5

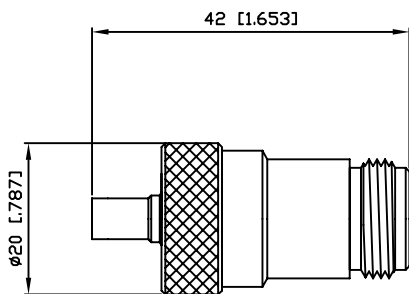

SERIES		$\Omega$	<i>ALFA'R CODE</i> CÓDIGO ALFA'R	TABLE TABLA
f	f			
MCX	N	50	A-AD-MCX-N-00-50	16.2

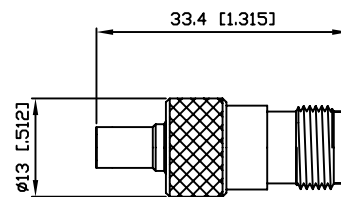

SERIES		$\Omega$	<i>ALFA'R CODE</i> CÓDIGO ALFA'R	TABLE TABLA
f	f			
MCX	TNC	50	A-AD-MCX-TNC-00-50	16.6

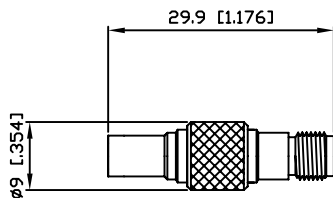

SERIES		$\Omega$	<i>ALFA'R CODE</i> CÓDIGO ALFA'R	TABLE TABLA
f	f			
MCX	SMA	50	A-AD-MCX-SMA-00-50	16.3

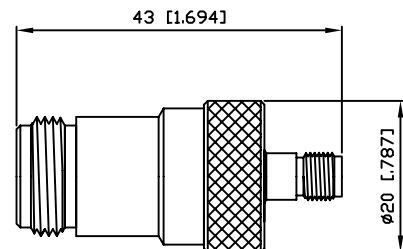

SERIES		$\Omega$	<i>ALFA'R CODE</i> CÓDIGO ALFA'R	TABLE TABLA
f	f			
N	SMA	50	A-AD-N-SMA-00-50	16.7

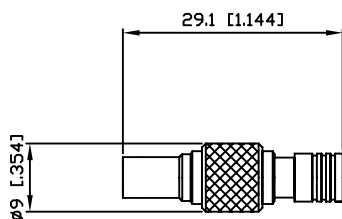

SERIES		$\Omega$	<i>ALFA'R CODE</i> CÓDIGO ALFA'R	TABLE TABLA
f	f			
MCX	SMB	50	A-AD-MCX-SMB-00-50	16.4

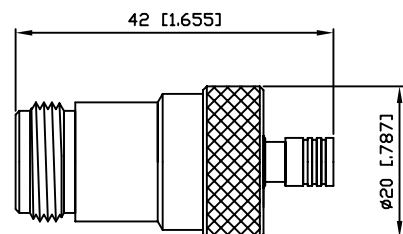

SERIES		$\Omega$	<i>ALFA'R CODE</i> CÓDIGO ALFA'R	TABLE TABLA
f	f			
N	SMB	50	A-AD-N-SMB-00-50	16.8



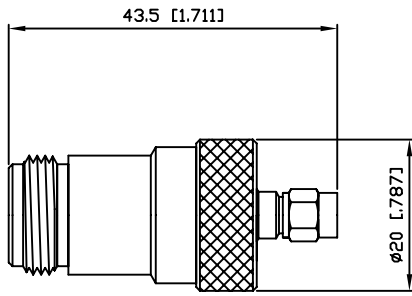

SERIES		$\Omega$	ALFA'R CODE CÓDIGO ALFA'R	TABLE TABLA
f	f			
N	SMC	50	A-AD-N-SMC-00-50	17.1

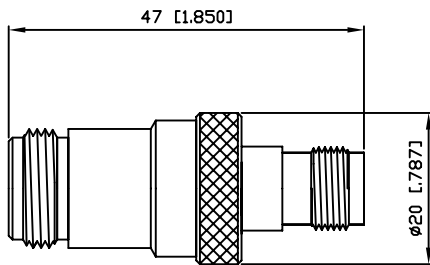

SERIES		$\Omega$	ALFA'R CODE CÓDIGO ALFA'R	TABLE TABLA
f	f			
N	TNC	50	A-AD-N-TNC-00-50	17.2
		75	A-AD-N-TNC-00-75	

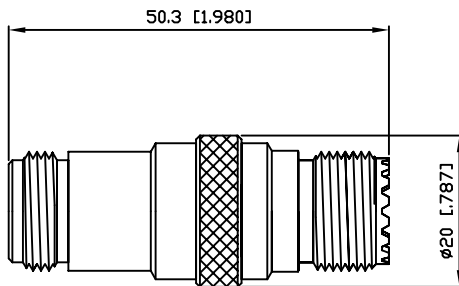

SERIES		$\Omega$	ALFA'R CODE CÓDIGO ALFA'R	TABLE TABLA
f	f			
N	UHF	50	A-AD-N-UHF-00-50	17.3

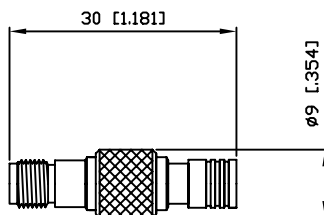

SERIES		$\Omega$	ALFA'R CODE CÓDIGO ALFA'R	TABLE TABLA
f	f			
SMA	SMB	50	A-AD-SMA-SMB-00-50	17.4

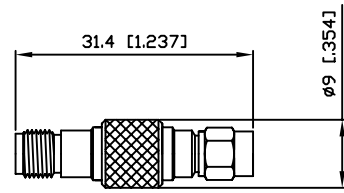

SERIES		$\Omega$	ALFA'R CODE CÓDIGO ALFA'R	TABLE TABLA
f	f			
SMA	SMC	50	A-AD-SMA-SMC-00-50	17.5

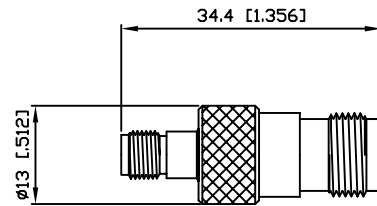

SERIES		$\Omega$	ALFA'R CODE CÓDIGO ALFA'R	TABLE TABLA
f	f			
SMA	TNC	50	A-AD-SMA-TNC-00-50	17.6

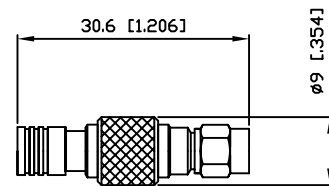

SERIES		$\Omega$	ALFA'R CODE CÓDIGO ALFA'R	TABLE TABLA
f	f			
SMB	SMC	50	A-AD-SMB-SMC-00-50	17.7

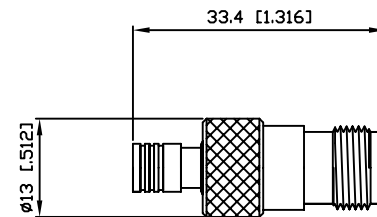

SERIES		$\Omega$	ALFA'R CODE CÓDIGO ALFA'R	TABLE TABLA
f	f			
SMB	TNC	50	A-AD-SMB-TNC-00-50	17.8

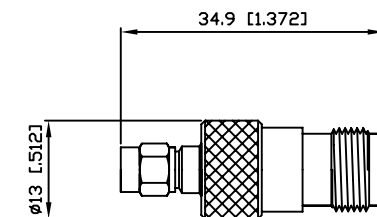

SERIES		$\Omega$	ALFA'R CODE CÓDIGO ALFA'R	TABLE TABLA
f	f			
SMC	TNC	50	A-AD-SMC-TNC-00-50	17.9